





BES12S3

MICROGRID SYSTEM

SPECIFICATION



BES12S3 Hybrid Energy System

Item	Unit	Data		
Output power	kVA/kW	12/12		
Frequency	Hz	50		
Phase	P	3		
Power factor	PF	1		
Dimensions	mm	2100 x 1150 x 1700		
Dry weight	kg	1100		
40" Loading	Qty	11		
Noise level(hybrid mode)	dBA@7m	58		
Noise level(battery mode)	dBA@7m	50		
Voltage	AC V	380	400	415
Current	A	18	17	17
Wiring port		L1、L2、L3、N、PE		
Voltage regulation range		±1%		
Load adaptation characteristics		Inductive load, resistive load		
Power connection input		3P Socket, 32A Busbar, 32A		
Power connection output		3P Main load socket, 32A Busbar, 32A 1P Socket, 16A		
Certification standards		     <p>UN 38.3 IEC 62619 IEC 62477 IEC 62933-2-1 CE Declaration of Conformity VDE-AR-N 4110 EN-50549-1 UL 1973</p>		

Classified Document
2024.04

System working principle

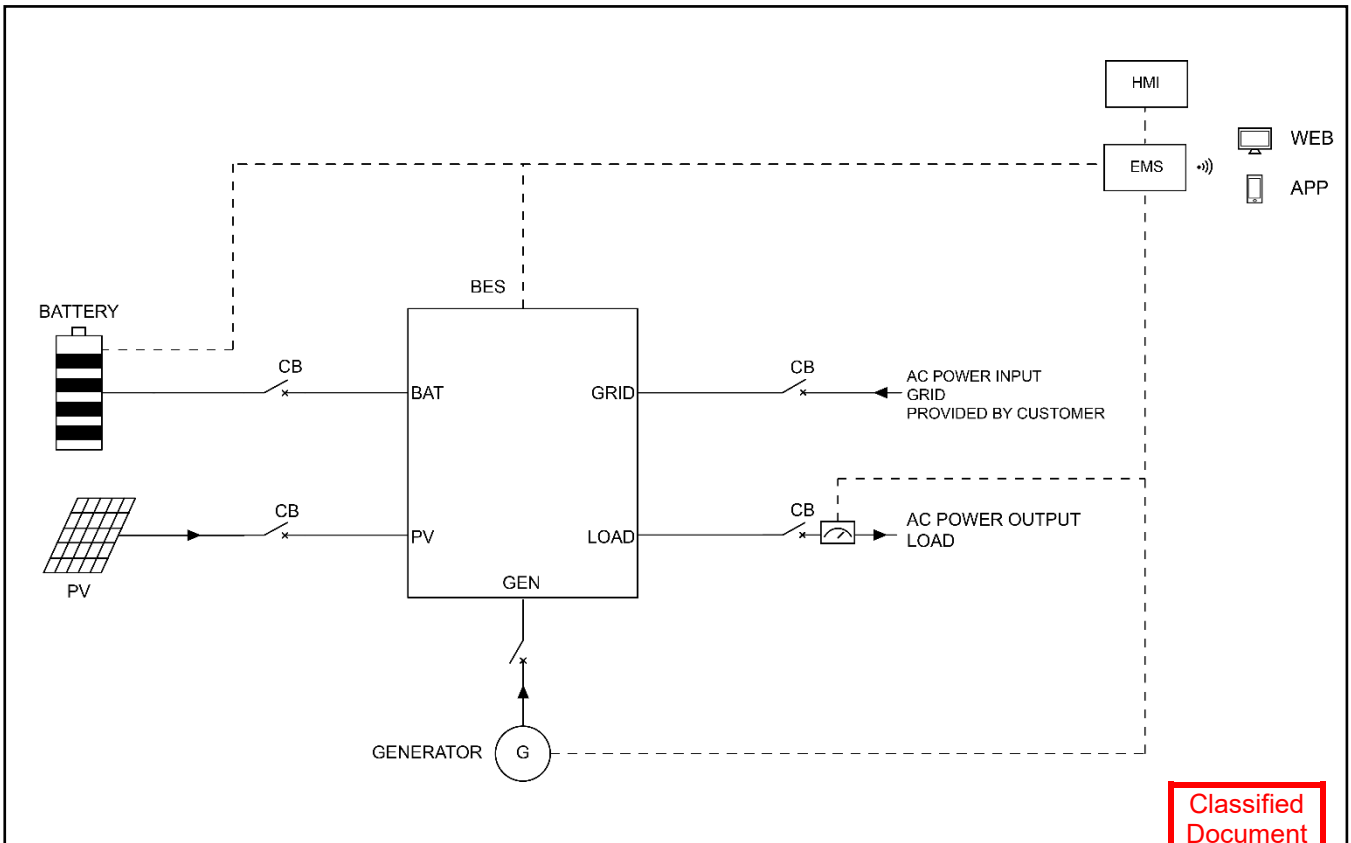

Classified Document

2024.04

Intelligent Energy Management

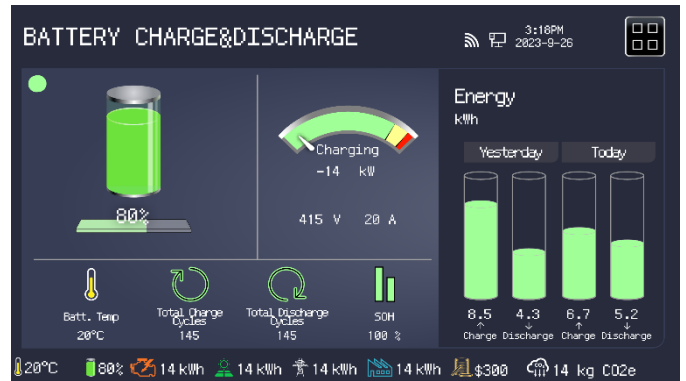
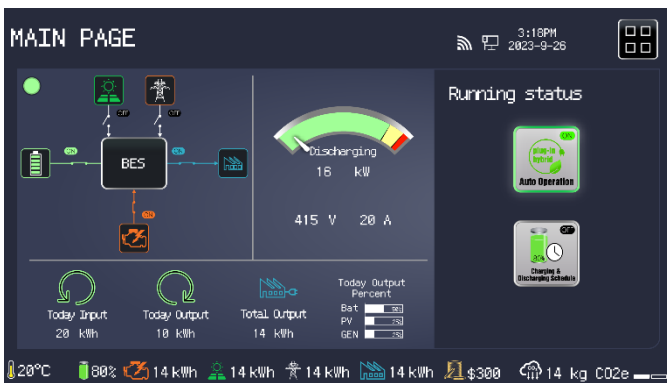

DC/AC System		
Rated power	kVA/kW	12/12
Output voltage	AC V	415/240
Overload capability		125% last 10mins, 150% last 1min

Grid Power Input		
Rated power	kVA/kW	12/12
Phase	P	3

PV System		
MPPT rated power	kWp	16
Rated voltage	DC V	150-425
Solar panel voltage	DC V	250
Solar panel capacity	kWp	2.5

Battery System		
Battery type		LiFePO4
Battery capacity	kWh	20
Rated voltage	DC V	40-60
Cooling system		Liquid-cooled
Max charging rate		1C
Max discharging rate		1C
Recommended discharging rate		1C
Battery cycle life		>8000cycles(90%DOD, 1C)

Diesel Generation System		
Engine brand / model		Kubota / D1803
Alternator brand		STAMFORD
Rated power	kVA/kW	18/14
Rated voltage	AC V	415/240
Phase	P	3
Fuel tank capacity	L	200

CONTROL SYSTEM		
HMI control panel	inch	10.3" Touchscreen
Communication interface		WAN/WIFI/SIM
Cloud services		APP/WEB

* Data is subject to change without prior notice as new products are always developed.

Please contact POWERLINK or local agent with any doubts or for more information.

Classified
Document
2024.04

