







BES34S3

ALL-IN-ONE ENERGY SYSTEM

SPECIFICATION



BES34S3 Battery/Solar/Diesel All-in-one Energy System

Item	Unit	Data		
Output power	kVA/kW	34/34		
Frequency	Hz	50		
Phase	P	3		
Power factor	PF	1		
Dimensions	mm	2300 x 1450 x 2570		
Dry weight	kg	3000		
40' Loading	Qty	8		
Noise level(hybrid mode)	dBa@7m	58		
Noise level(battery mode)	dBa@7m	50		
Voltage	AC V	380	400	415
Current	A	52	49	47
Wiring port		L1、L2、L3、N、PE		
Voltage regulation range		±1%		
Load adaptation characteristics		Inductive load, resistive load		
Power connection input		3P Socket Busbar		
Power connection output		3P Main load socket Busbar 1P Socket		
Certification standards		 UN 38.3  IEC 62619  IEC 62477  IEC / EN 60529  EN 61000-6-1/2/3/4  AS 4777.2 G99 CE Declaration of Conformity		

Classified
 Document
 2024.12.12

System working principle

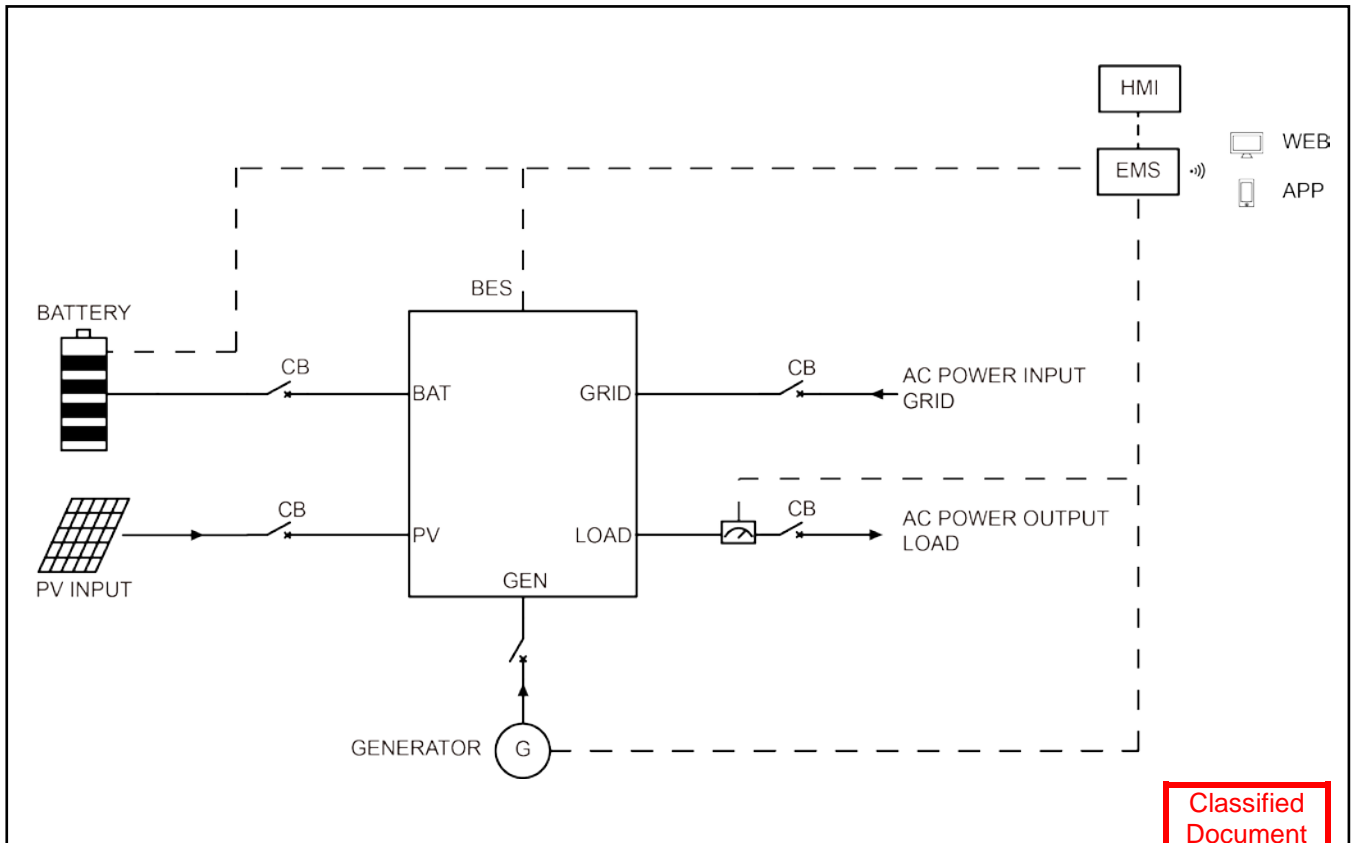

Classified Document

2024.12.12

Intelligent Energy Management

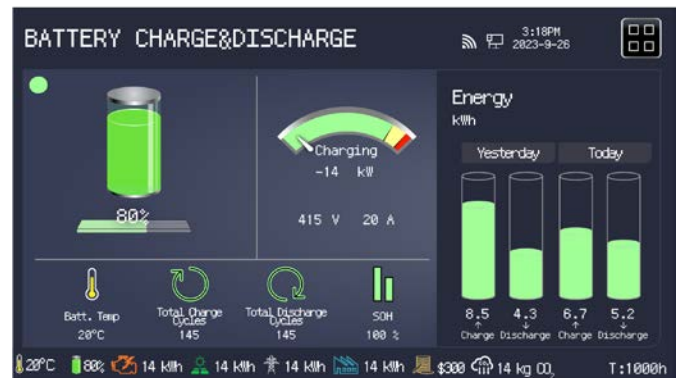

DC/AC System		
Rated power	kVA/kW	34/34
Output voltage	AC V	380/400/415

Grid Power Input		
Rated power	kVA/kW	34/34
Phase	P	3

PV System		
MPPT rated power	kWp	52
Rated voltage	DC V	150-850
Solar panel voltage	DC V	245
Solar panel capacity	kWp	3.5

Battery System		
Battery type		LiFePO4
Battery capacity	kWh	51.8
Rated voltage	DC V	384
Cooling system		Liquid-cooled
Max charging rate		1C
Max discharging rate		1C
NOTE: The discharge power decreases as the battery SOC decreases.		

Diesel Generation System		
Engine brand / model		Kubota / V3800DI
Alternator brand		Powerlink
Rated power	kVA/kW	45/36
Rated voltage	AC V	415
Phase	P	3
Fuel tank capacity	L	200

Control System		
HMI control panel	inch	10.3" Touchscreen
Communication interface		WAN/WIFI/SIM
Cloud services		APP/WEB

* Data is subject to change without prior notice as new products are always developed.
Please contact POWERLINK or local agent with any doubts or for more information.

Classified
Document
2024.12.12

