





IHE400

INDUSTRIAL ENERGY STORAGE SYSTEM

SPECIFICATION



IHE400 Industrial Energy Storage System				
Item	Unit	Data		
Output power	kVA/kW	400/400		
Frequency	Hz	50		
Phase	P	3		
Power factor	PF	1		
Dimensions	mm	3200x1500x2200		
Dry weight	kg	14000		
40' Loading	Qty	3		
Protection class		IP54		
Noise level	dBA@7m	58		
Voltage	AC V	380	400	415
Current	A	608	577	556
Wiring port		L1、L2、L3、N、PE		
Voltage regulation range		±1%		
Load adaptation characteristics		Inductive load, resistive load		
Power connection input		AC socket: 3P/4W, 1x400kW		
Power connection output		AC socket: 3P/4W, 1x400kW		
Certification standards		    <p>UN 38.3 IEC 62619 IEC 62477 IEC / EN 60529 EN 61000-6-1/2/3/4 AS 4777.2 G99 CE Declaration of Conformity</p>		

Classified
Document
2024.12.12

System Working Principle

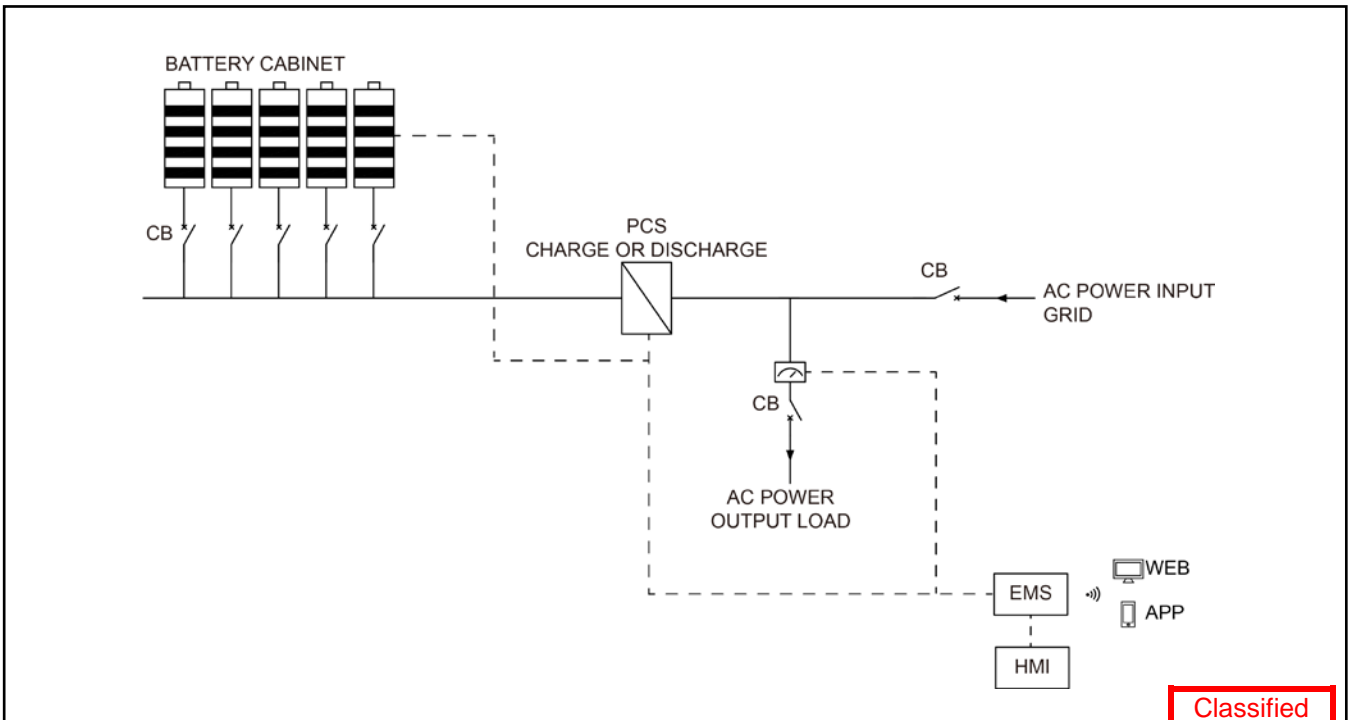

Classified
Document
2024.12.12

Intelligent Energy Management

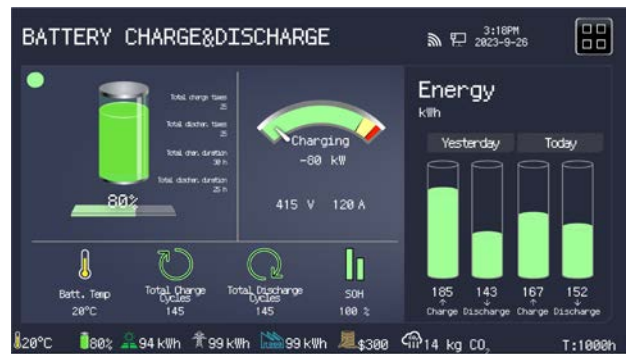

DC/AC System		
Rated power	kVA/kW	400/400
Output voltage	AC V	380/400/415

Grid Power Input		
Rated power	kVA/kW	400/400
Phase	P	3

Battery System		
Battery type		LiFePO4
Battery capacity	kWh	832
Cooling system		Liquid-cooled
Max charging rate		0.5C
Max discharging rate		0.5C
NOTE: The discharge power decreases as the battery SOC decreases.		

Control System		
HMI control panel	inch	10.3" Touchscreen
Communication interface		WAN/WIFI/SIM
Cloud services		APP/WEB

* Data is subject to change without prior notice as new products are always developed.
Please contact POWERLINK or local agent with any doubts or for more information.

Classified
Document
2024.12.12