

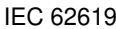

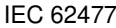

PES200

PORTABLE HYBRID ENERGY SYSTEM

SPECIFICATION



PES200 Portable Hybrid Energy System				
Item	Unit	Data		
Output power	kVA/kW	200/200		
Frequency	Hz	50		
Phase	P	3		
Power factor	PF	1		
Dimensions	mm	3840×2290×2525		
Dry weight	kg	5200		
40' Loading	Qty	3		
Protection class		IP54		
Noise level	dBA@7m	58		
Voltage	AC V	380	400	415
Current	A	304	289	278
Wiring port		L1、L2、L3、N、PE		
Voltage regulation range		±1%		
Load adaptation characteristics		Inductive load, resistive load		
Power connection input		AC socket: 3P/4W, 1x200kW, 1x50kW DC socket: 1x50kW		
Power connection output		AC socket: 3P/4W, 1x200kW AC socket: 1P		
Certification standards		 UN 38.3  IEC 62619  IEC 62477  ISO 9001  CE  IEC IEC / EN 60529 EN 61000-6-1/2/3/4 CE Declaration of Conformity		

Classified Document
 2024.12.12

Intelligent Energy Management

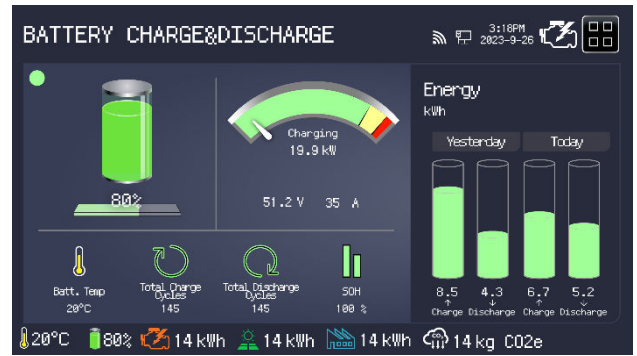

System Working Principle

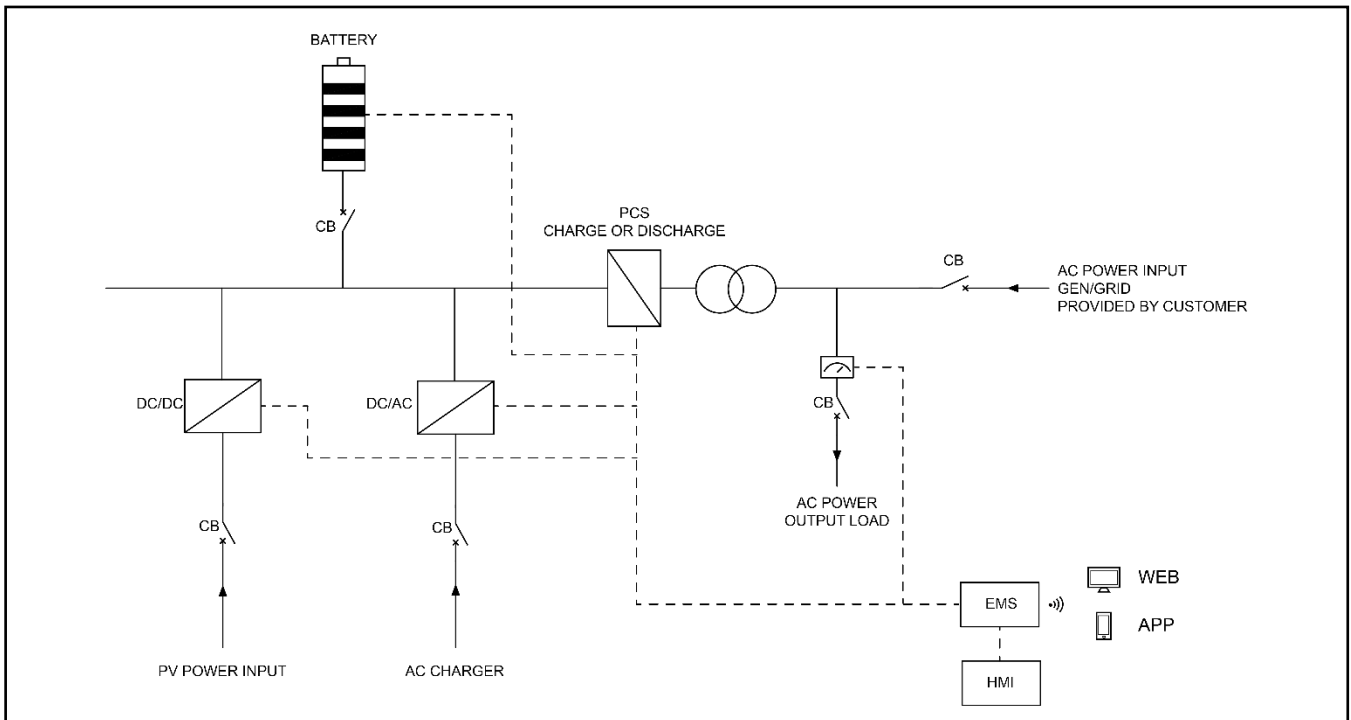

DC/AC System		
Rated power	kVA/kW	200/200
Output voltage	AC V	380/400/415
Standby AC charger power	kW	50

PV System		
Rated power	kWp	50
Input voltage	DC V	150-650
NOTE: Solar panels are optional.		

Battery System		
Battery type		LiFePO4
Battery capacity	kWh	230.4
Rated voltage	DC V	768
Cooling system		Air-cooled
Max charging rate		1C
Max discharging rate		1C
NOTE: The discharge power decreases as the battery SOC decreases.		

Control System		
HMI control panel	inch	13" Touchscreen
Communication interface		WAN/WIFI/SIM
Cloud services		APP/WEB

* Data is subject to change without prior notice as new products are always developed.

Please contact POWERLINK or local agent with any doubts or for more information.

Classified Document
 2024.12.12